

# SHINDENGEN

## Schottky Rectifiers (SBD)

Single

# M1FP3

## 30V 1.29A

### FEATURES

Small SMT  
Super low  $V_f=0.4V$

### APPLICATION

Reversed Battery Connection Protection  
DC OR output  
DC/DC converter  
Mobile telephone, personal computer

### OUTLINE DIMENSIONS

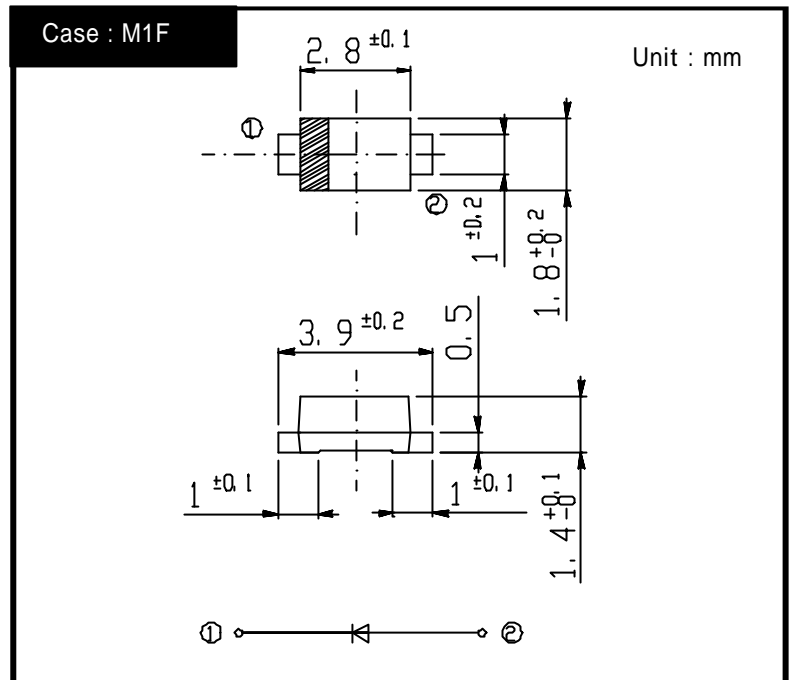

### RATINGS

Absolute Maximum Ratings (If not specified  $T_I=25$  )

Item	Symbol	Conditions	Ratings	Unit
Storage Temperature	$T_{stg}$		-55 ~ 125	
Operating Junction Temperature	$T_j$		125	
Maximum Reverse Voltage	$V_{RM}$		30	V
Average Rectified Forward Current	$I_o$	50Hz sine wave, R-load $T_a=25$ On alumina substrate	1.29	A
		50Hz sine wave, R-load $T_I=109$ On glass-epoxy substrate	1.1	
Peak Surge Forward Current	$I_{FSM}$	50Hz sine wave, Non-repetitive 1 cycle peak value, $T_I=25$	30	A

Electrical Characteristics (If not specified  $T_I=25$  )

Item	Symbol	Conditions	Ratings	Unit
Forward Voltage	$V_F$	$I_F=0.4A$ , Pulse measurement	Max.0.35	V
		$I_F=1.1A$ , Pulse measurement	Max.0.40	
Reverse Current	$I_R$	$V_R=30V$ , Pulse measurement	Max.2.5	mA
Junction Capacitance	$C_j$	$f=1MHz$ , $V_R=10V$	Typ.90	pF
Thermal Resistance	$\theta_j$	junction to lead	Max.20	/W
		junction to ambient On alumina substrate	Max.108	
		junction to ambient On glass-epoxy substrate	Max.186	

# M1FP3

# Forward Voltage

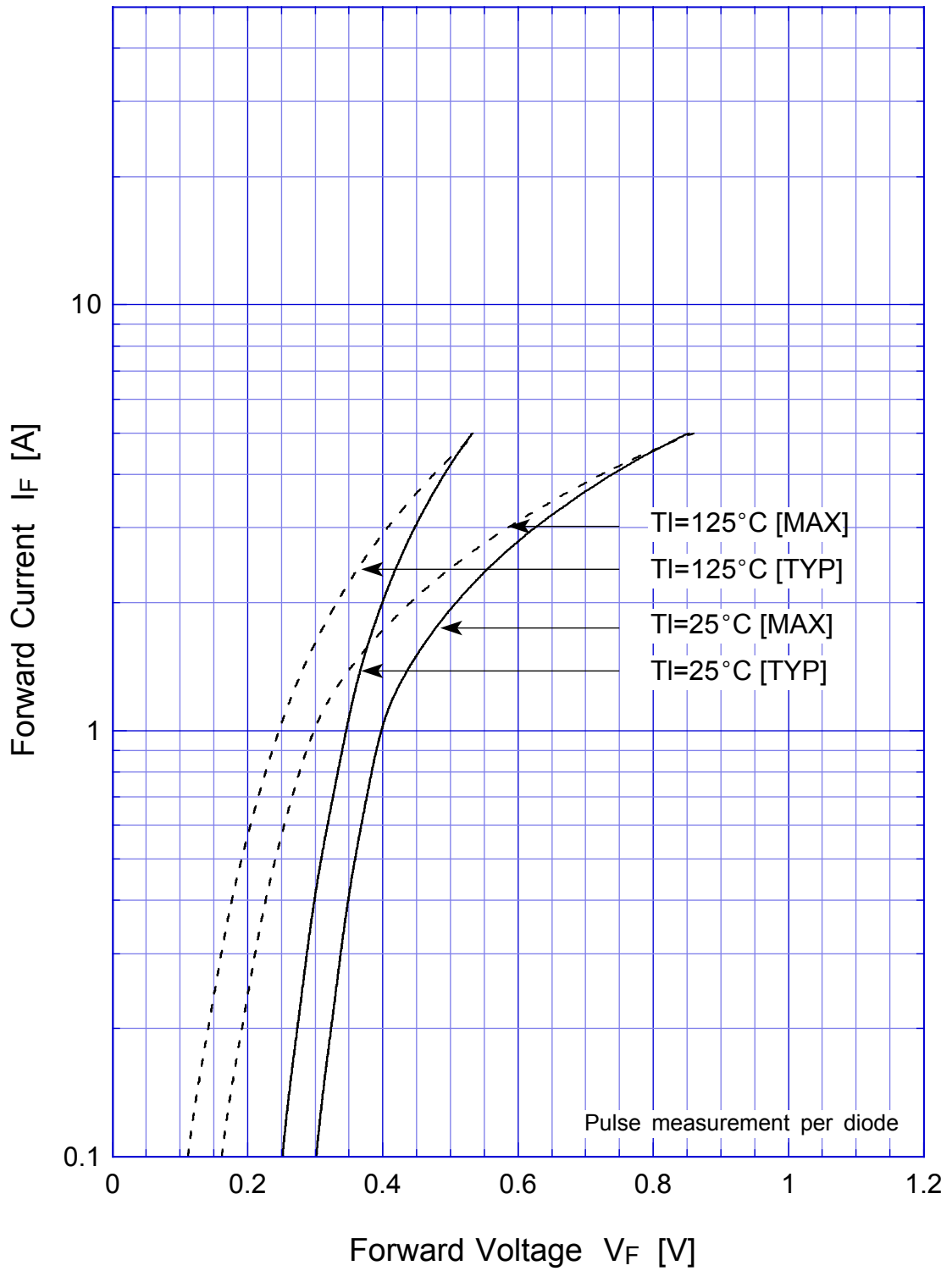

# M1FP3

## Junction Capacitance

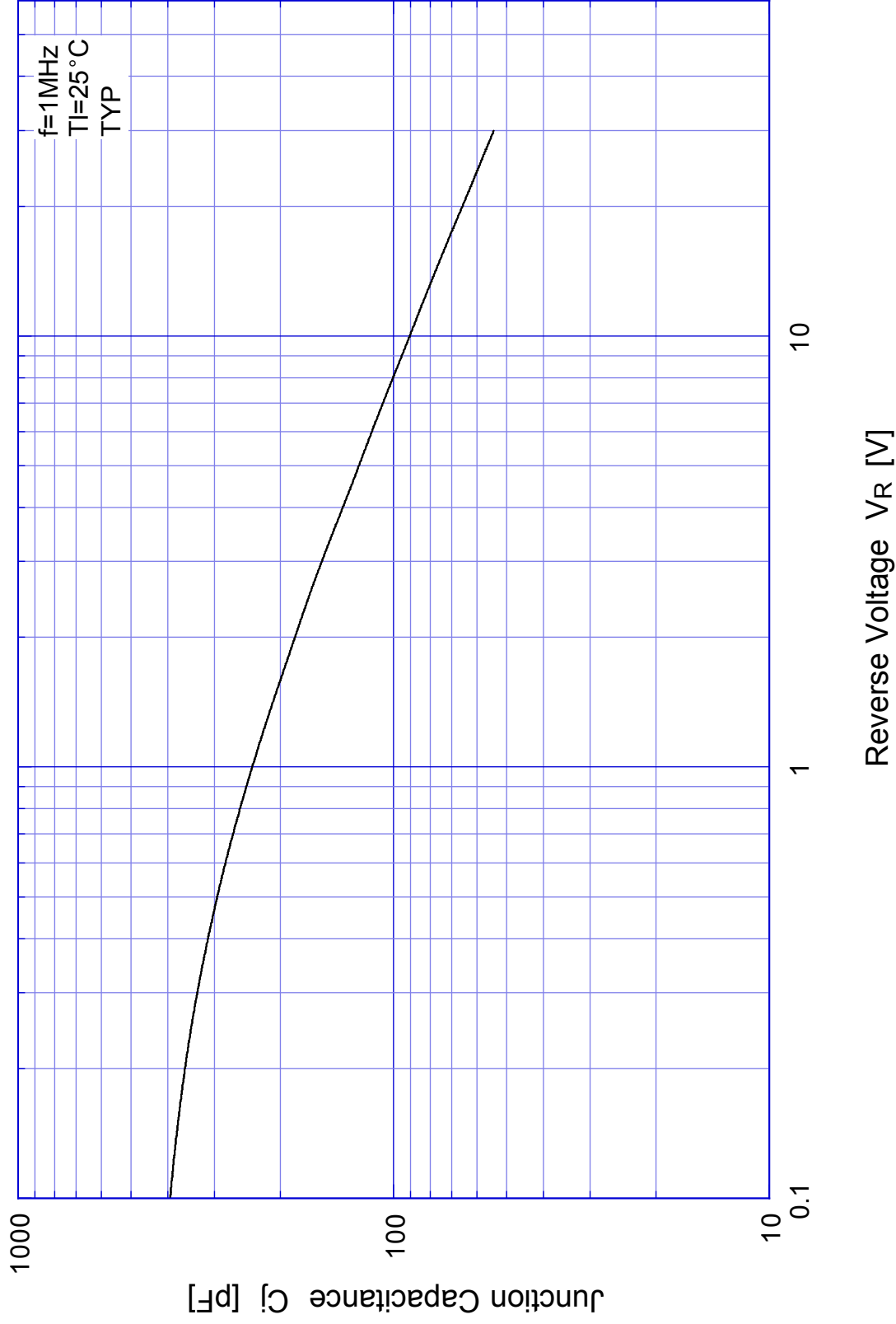

# M1FP3

# Reverse Current

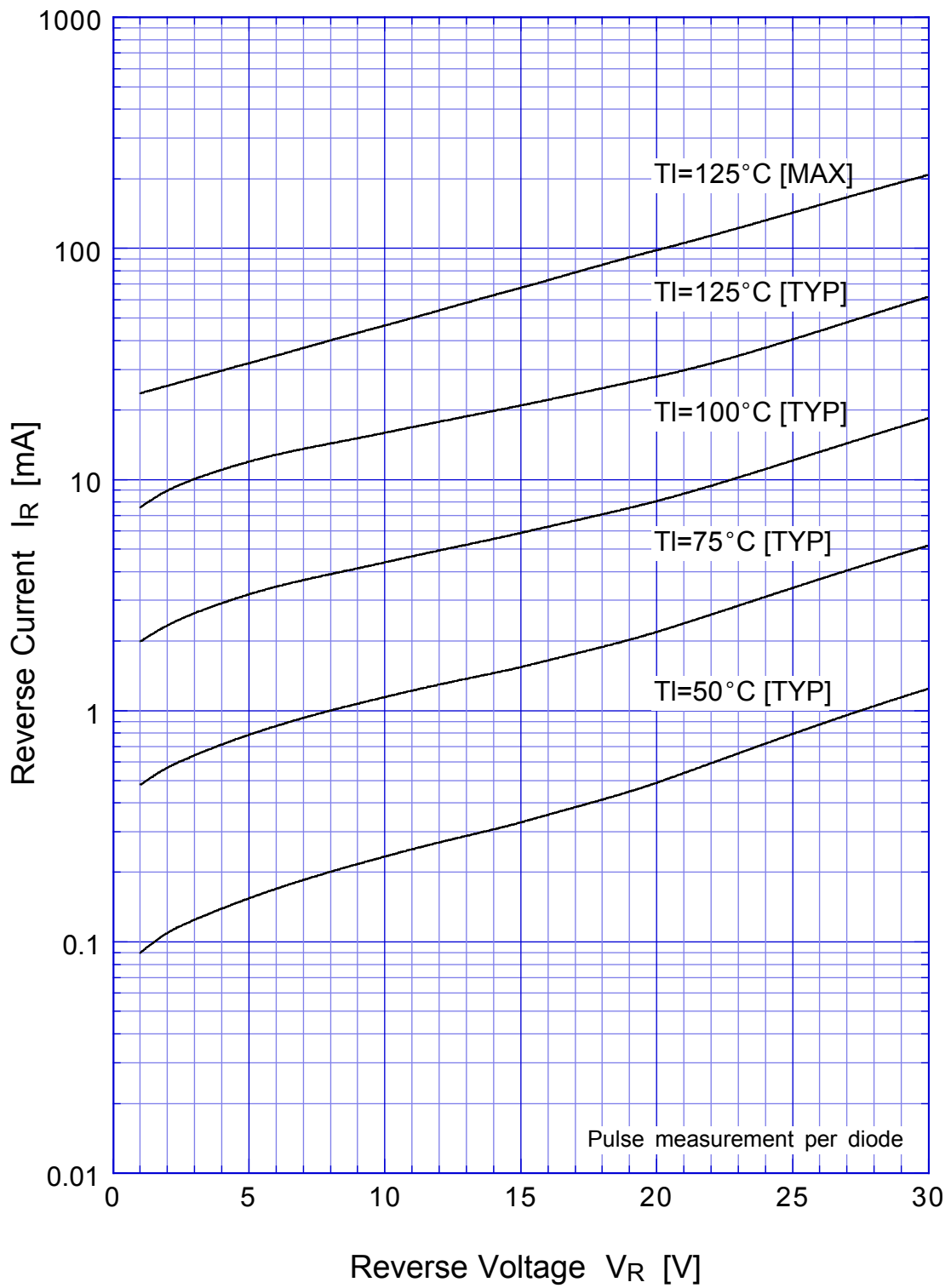

# M1FP3

## Reverse Power Dissipation

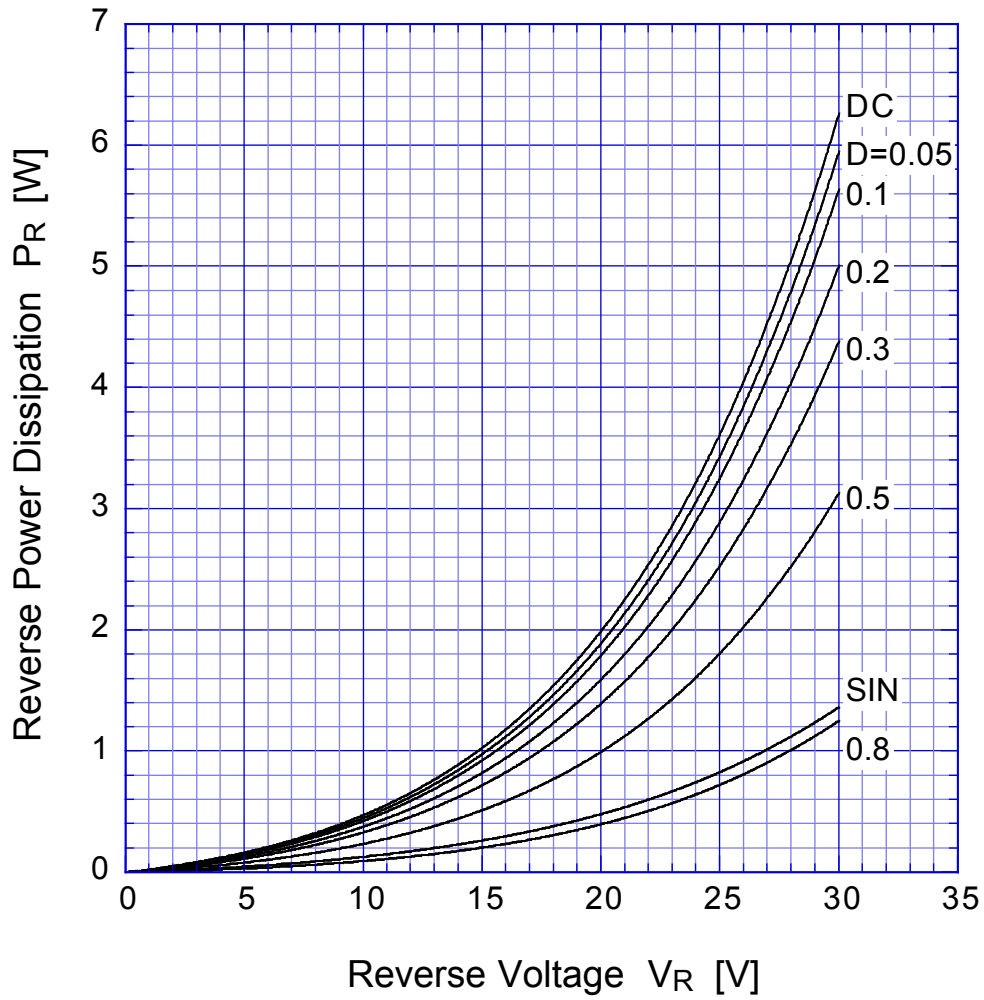

$T_j = 125^\circ\text{C}$

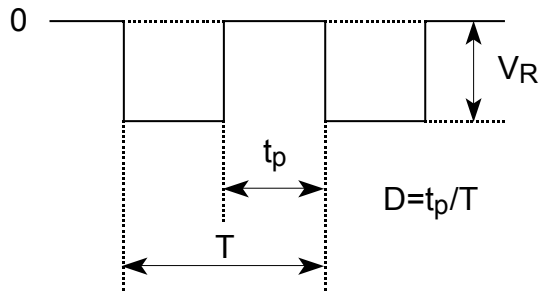

# M1FP3

## Forward Power Dissipation

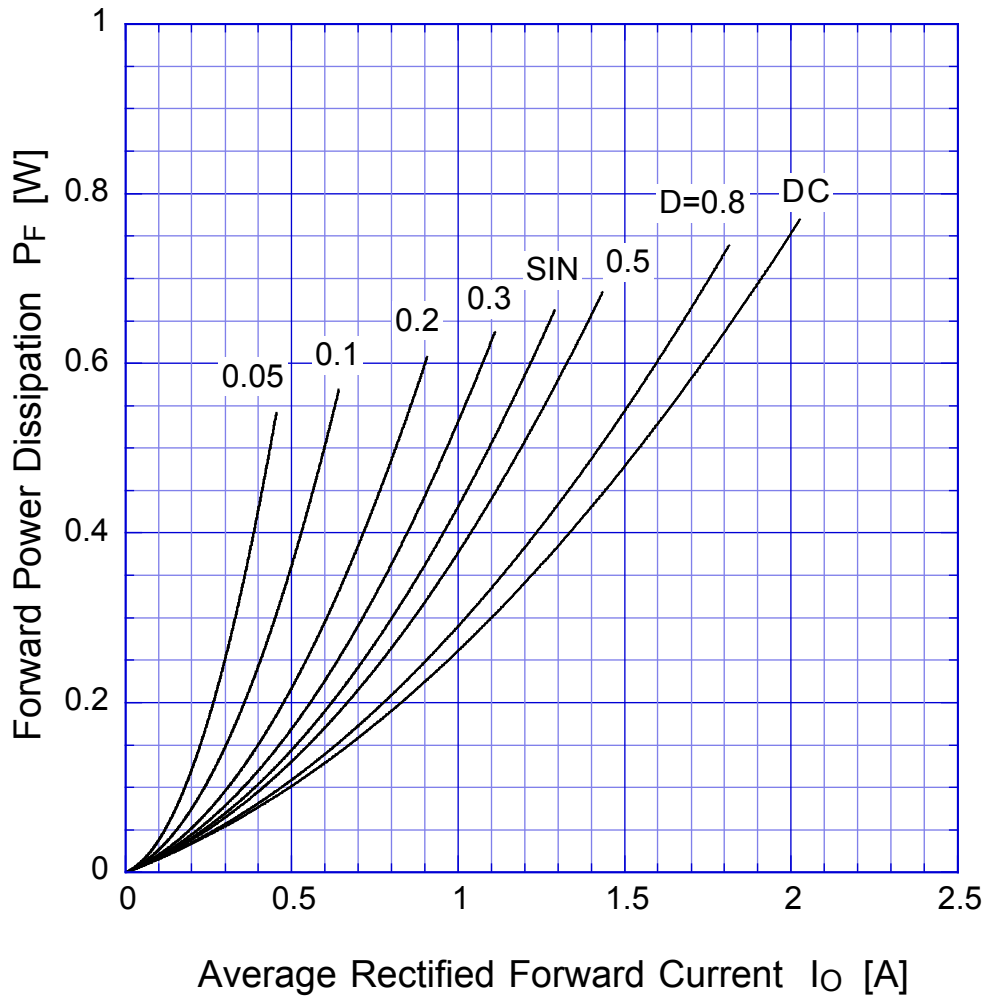

$T_j = 125^\circ\text{C}$

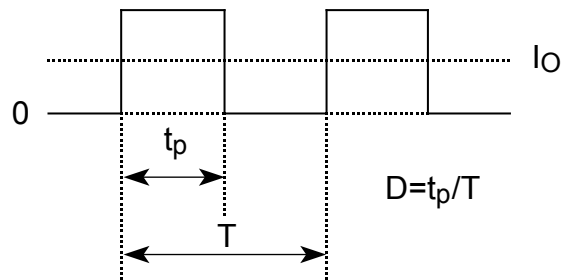

# M1FP3

# Derating Curve

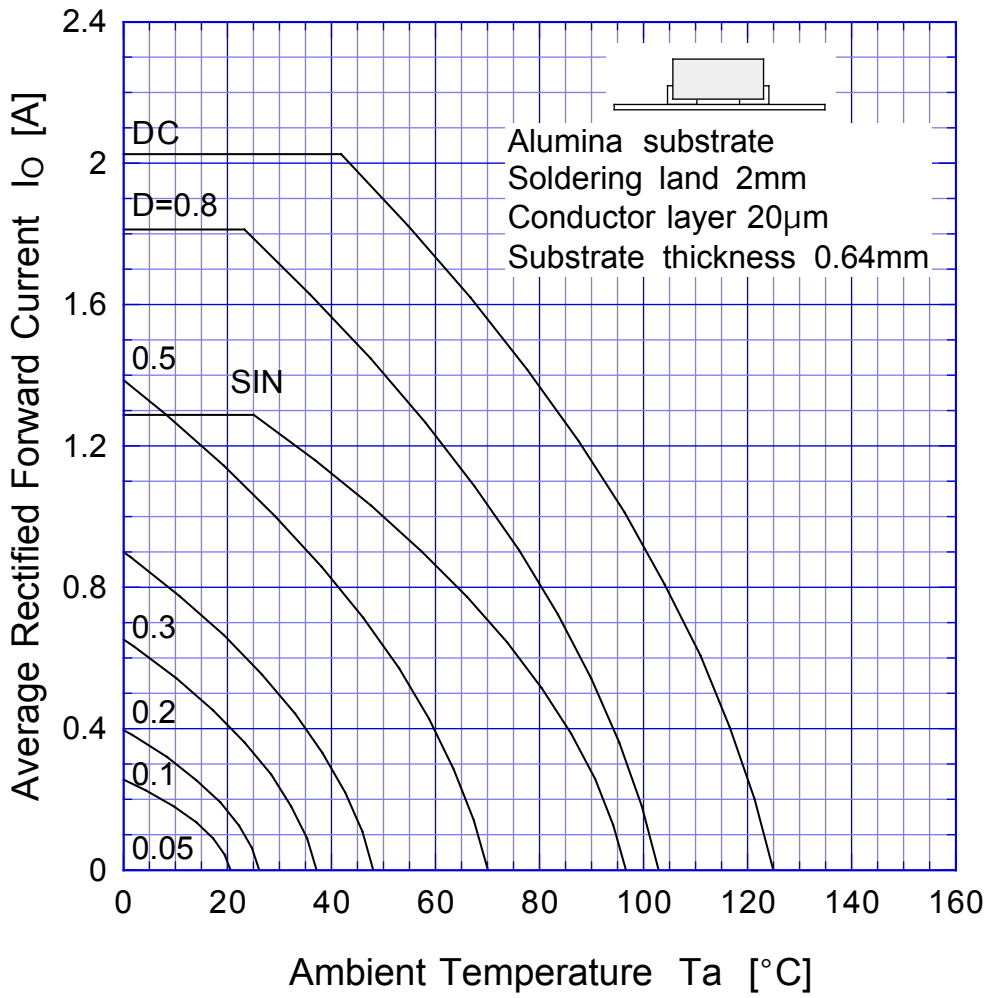

$V_R = 15V$

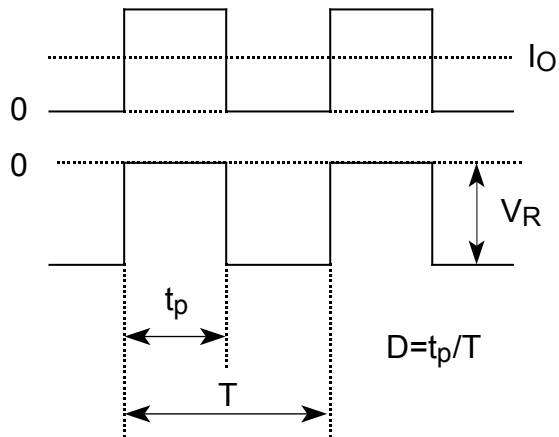

# M1FP3

# Derating Curve

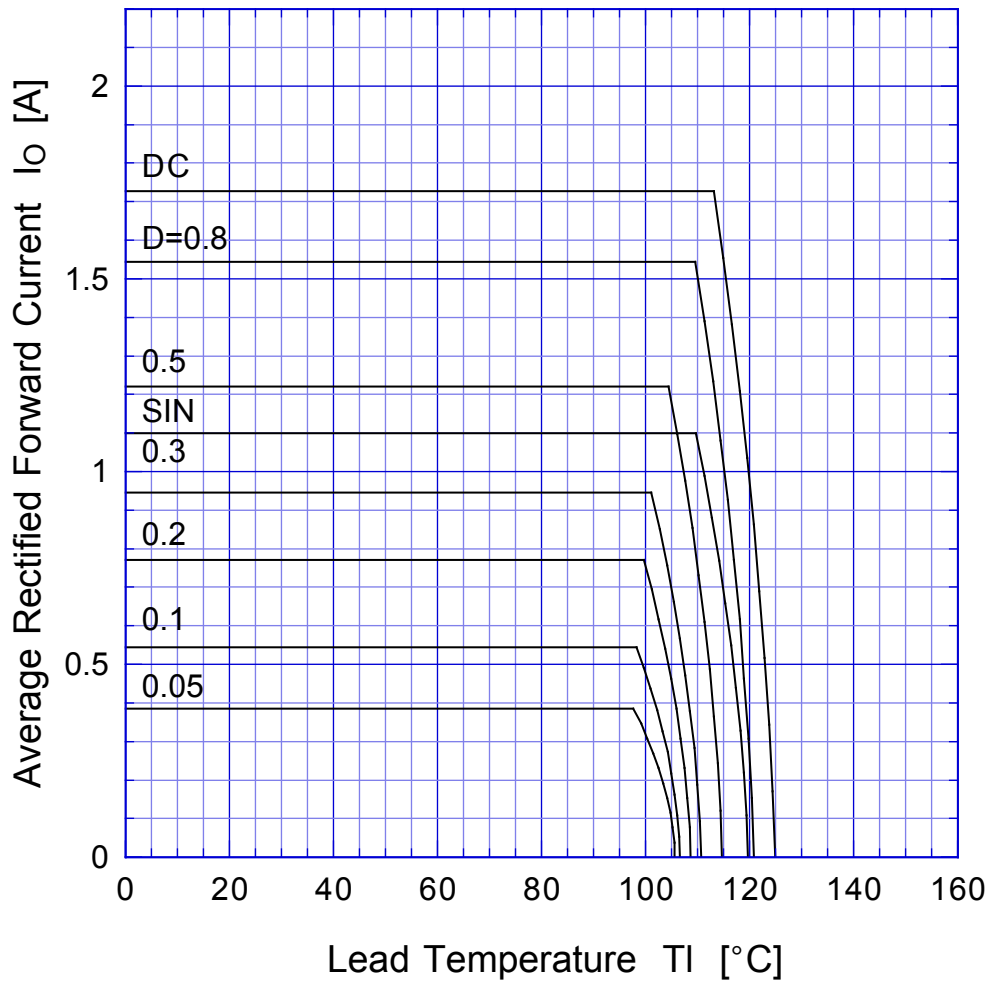

$V_R = 15V$





# M1FP3

## Peak Surge Forward Capability

